



Droplet Coalescence in Microfluidic Systems

Author

Xu, B, Nguyen, NT, Wong, TN

Published

2011

Journal Title

Micro and Nanosystems

DOI

[10.2174/1876402911103020131](https://doi.org/10.2174/1876402911103020131)

Rights statement

© 2011 Bentham Science Publishers. This is the author-manuscript version of this paper. Reproduced in accordance with the copyright policy of the publisher. Please refer to the journal website for access to the definitive, published version.

Downloaded from

<http://hdl.handle.net/10072/62210>

Griffith Research Online

<https://research-repository.griffith.edu.au>

Droplet Coalescence in Microfluidic Systems

Bin Xu, Nam-Trung Nguyen*, Teck Neng Wong

School of Mechanical and Aerospace, Nanyang Technological University

50 Nanyang, Avenue, Singapore 639798

*Corresponding author. E-mail: mntnguyen@ntu.edu.sg

Abstract

Droplet coalescence is one of the most attractive manipulation schemes in droplet-based microfluidic systems, which enables droplet-based functions such as mixing and microreactor to be achieved in lab-on-a-chip applications. This paper systematically presents an overview on techniques used for droplet coalescence in microfluidic systems. In this paper, techniques employed for droplet coalescence are categorized as passive and active types. The basic theory and mechanism behind these techniques are also presented.

Key words: droplet-based, coalescence, mixing, fusion, microfluidics

1. Introduction

With the ability of forming mono dispersed droplets in microscale, droplet-based microfluidics have been receiving attention from the research community in recent years [1]. Compared to continuous-flow microfluidics, droplet-based microfluidics have many advantages such as faster mixing, shorter residence time and low cross contamination [2-4]. Due to these advantages, droplet-based microfluidics have been developed in a variety of biological applications such as mixing [5], microreactor [4], on-chip PCR [6], protein crystallizations [7] and many other lab-on-a-chip (LOC) bio-analytical devices [8]. An important process during these applications is the mixing of fluids in the droplets, for instance, by fusion of two droplets. Droplet fusion is driven by interfacial forces where two droplets have a larger interfacial area than a single droplet of the same volume [9].

To merge two droplets in a microchannel, the continuous phase separating the two droplets needs to be removed. When the two droplets have a close contact with each other, a thin liquid bridge will form between the two droplets due to attractions between the molecules [10]. The high curvature meniscus formed around the bridge creates an imbalance of the surface tension which will quickly merge the two droplets [11].

In general, droplet coalescence techniques can be categorized as passive and active types. Passive droplet coalescence technique do not require external energy, the droplet coalescence process only rely on the structure of microchannel [10] and the surface properties [12]. Active droplet coalescence technique employs energy generated by an external field to realized droplet fusion process. This can be achieved by applying electric, magnetic and temperature field. In this review, passive and active droplet coalescence technique will be introduced respectively. Basic theory and mechanism will also be introduced.

2. Passive droplet coalescence

Flow trapping

As mentioned above, droplet coalescence can be achieved by removing the continuous phase which separates a pair of droplets. Based on this concept, passive trapping technique [13, 14] was proposed to realize the fusion between two droplets. The simplest way is to introduce a fluid resistance element to trap the droplet in the microchannel. With the help of the fluid resistance element, the trapped droplet will wait for the subsequence droplet. Two neighboring droplets have a chance to get close to each other due to the drainage of the continuous phase in the fluid resistance element. This process typically includes four steps: trapping, stop of trapped droplet, fusion of two pair wise droplet and release of fused droplets. Three different types of traps are demonstrated to show the fusion process, including a hindrance inside a channel, a locally enlarged diameter of fluid channel and a local asymmetry in the

cross-section shape as shown in Fig. (1). The total flowrate must match with the fluid resistance element. Droplet fusion can also be achieved at channel junctions as shown in Fig. (2). The principle is similar with the fluid traps used in a microchannel. This design requires synchronization of two subsequent droplets when they arrive at the Y-junction.

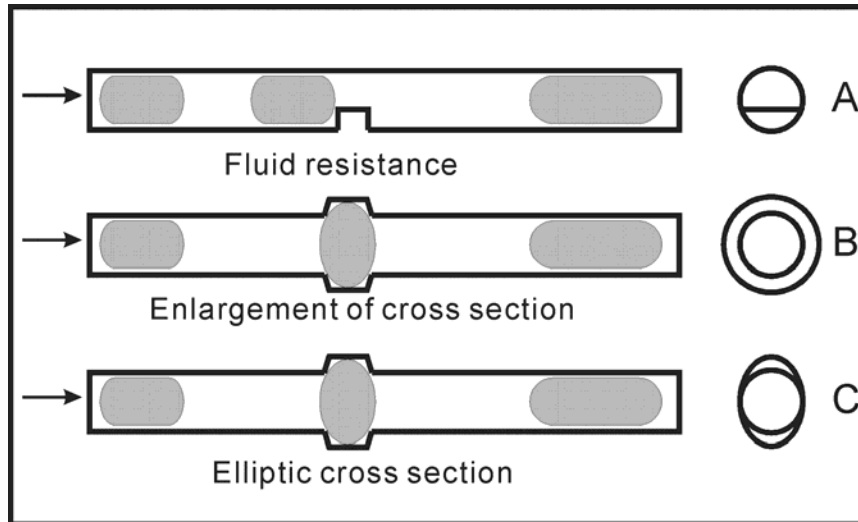

Fig. (1). Schematic illustration of fluid traps used in a microchannel. Cross sections are shown in the right: (A) wall step, (B) enlargement of cross section, (C) elliptic cross section

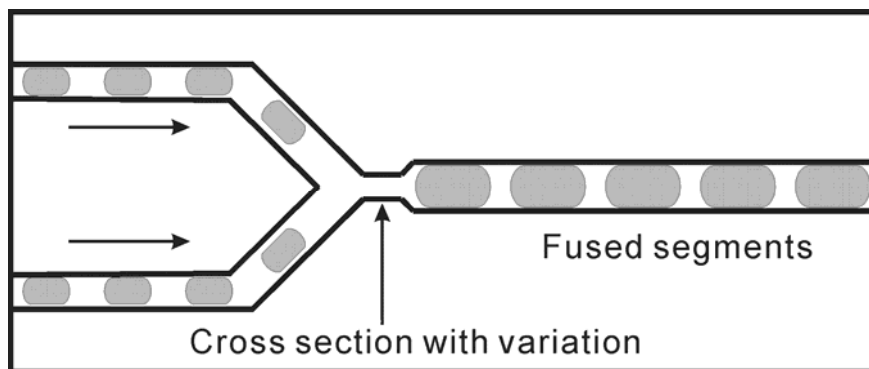

Fig. (2). Schematic illustration of fusion of droplets at a Y-junction

Similar to the above principle, three different channel geometries including a rectangular expansion, a tapered expansion and a flow rectifying design were investigated [10], Fig. (3). The rectangular expansion design enables the decelerate of droplet in the rectangular expansion. The separating fluid volume between the two droplets becomes smaller and droplet fusion can take places. The drawback of this

design is that it only works for a limited range of total flowrates and flowrate ratios of dispersed phase and continuous phase which is determined by the length and the width of the expansion. Undesired multiple droplet coalescence and droplet break up will occur if the total flowrates and flowrate ratios do not match with the rectangular expansion. The tapered expansion can be combined as a series of rectangular expansions allowing a wider range of total flowrates and flowrate ratios. Droplet in the tapered expansion will decelerate to a much slower speed due to the increasing drainage of the continuous phase. Due to the changed flow field, more subsequent droplets come close together. As a result, undesired multiple droplet will coalesce together.

Among the three designs, the rectification design is demonstrated to be a more effective design to fuse subsequent droplets. Compared with the rectangular and tapered expansions, the rectification design can drain the separating fluid volume at a controllable rate. In the rectification design, equal amounts of separating fluid are removed to the upper and lower channels with identical fluid resistance without the generation of a net force along the vertical axis. Droplet fusion process can be achieved by controlling the separating flowrates.

Bremond et al. [15] studied droplet fusion characteristics in a microchannel with rectangular expansion. When the two subsequent droplets encounter each other in the rectangular expansion, droplet fusion process does not occur. The fusion process was found to occur at the separation stage when the former droplet begins to leave the expansion. The formation of two face bulging portions will significantly increase the contacting surface area which leads to droplet fusion.

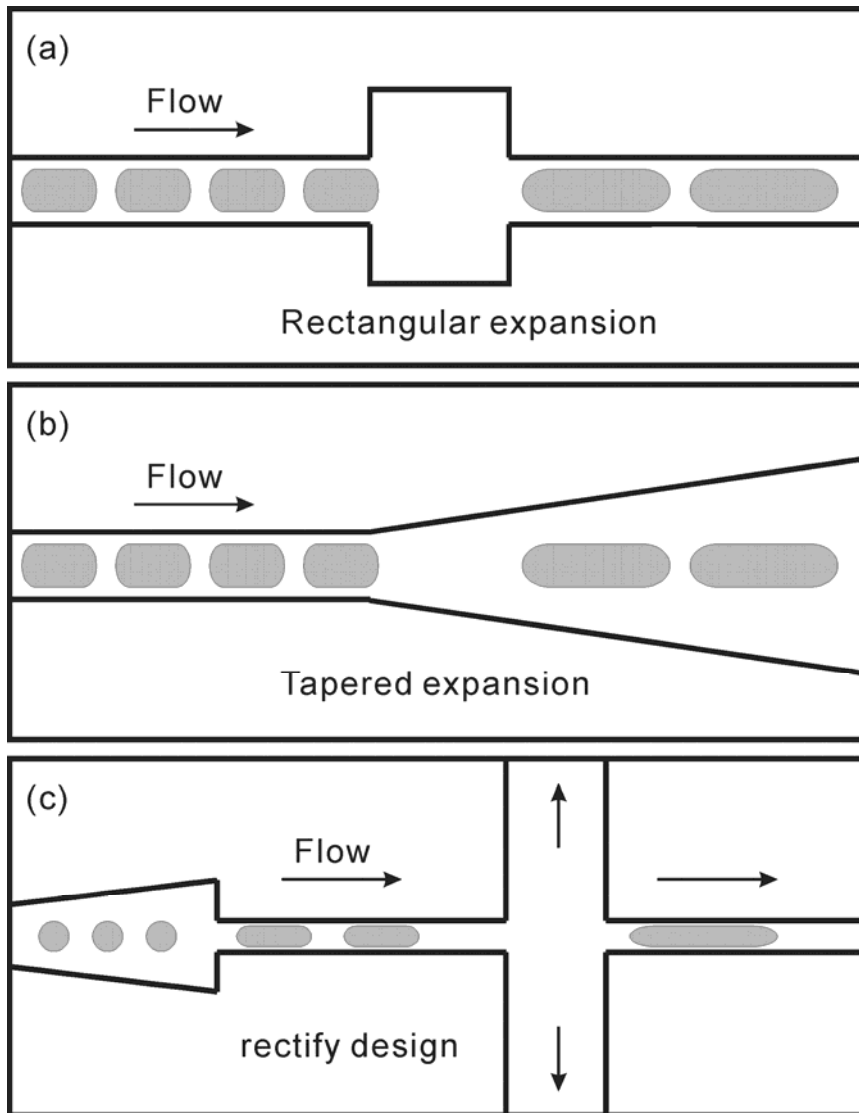

Fig. (3). Three different channel geometries. (a) Coalescence in channel with rectangular expansion, (b) Coalescence in channel with tapered expansion, (c) Coalescence in channel with rectification design

Followed by the previous studies, a multifunctional and highly efficient microfluidic device [16] was proposed as shown in Fig. (4). This device consists of three inlets, a double T-junction and a tapered merging chamber. Alternating droplet generation can be achieved within the double T-junction. Push-pull is the mechanism to generate the alternating droplet. Water stream 2 will be pushed with the generation of droplet coming out from the water stream 1. The increasing pressure forces will push water stream 2 into the pinch junction to generate the next droplet. Generated droplets are carried by the continuous phase to the tapered merging chamber. In the

tempered merging chamber, droplet will have a chance to approach each other with the drainage of oil film between droplets. The reduction of the channel width at the exit increases the flow pressure and evacuates the oil film. Droplet fusion can be achieved at the exit junction.

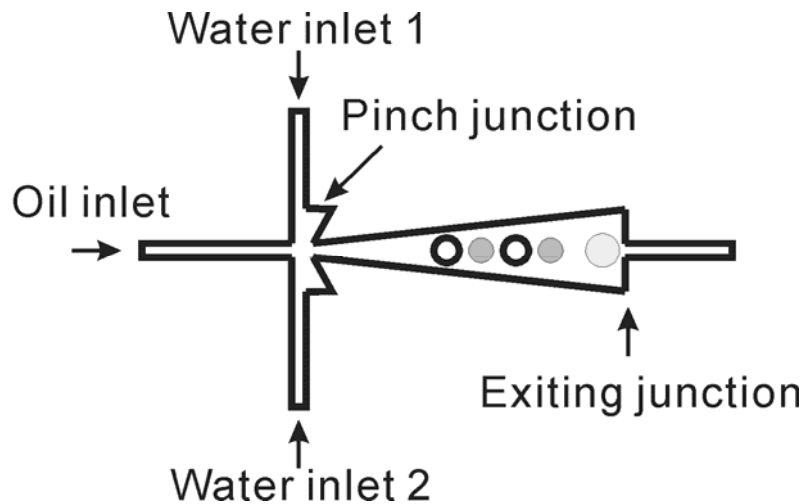

Fig. (4). Schematic illustration of the designed microchannel

A droplet merging device with pillars was proposed to control the distance between subsequent droplets [17]. A schematic illustration of this device is shown in Fig. (5). Rows of pillars separated by distances which are smaller than the droplet dimension is employed as fluid resistance element to assist droplet fusion. The mechanism of this method is to utilize the difference between the hydrodynamic resistance of the continuous phase and the surface tension of the dispersed phase through the use of pillars installed in the microchannel. When a droplet comes into the merging chamber, it will slow down and stop due to the fluid resistance element (pillar). The droplet will wait for subsequent droplets and then merge with them. When the hydraulic pressure is larger than the surface tension of the fused droplet, the droplet will move out of the merging chamber. This merging device can fuse two or multiple droplets through adjusting the mass flowrate and the volume ratio between the droplets and the merging chamber.

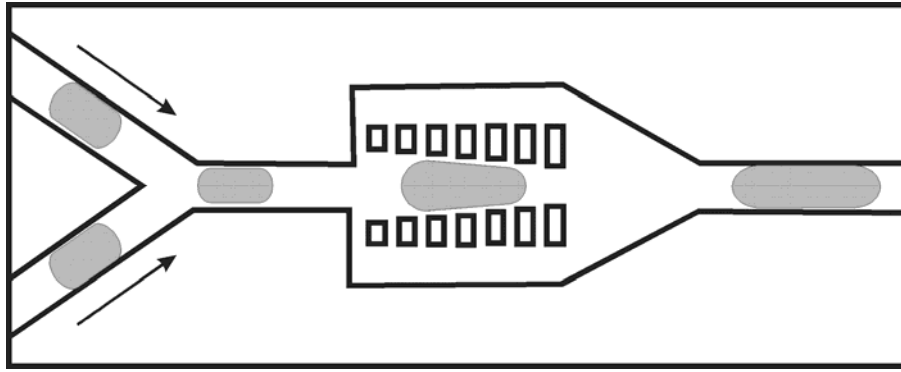

Fig. (5). Schematic illustration of pillar-induced droplet fusion device

Surface modification

Beside the flow trapping method, another passive droplet fusion method was reported based on the surface energy pattern on the walls of a microfluidic device as shown in Fig. (6) [12]. They patterned hydrophilic poly(acrylic acid) (PAA) and grafted via UV photopolymerization on planar benzophenone-containing poly(dimethyl siloxane) (PDMS) substrates to trap the aqueous droplets. The droplet fusion can be divided into two steps including droplet trapping and droplet detachment. The mechanism of this method is to make use of the differences between the viscous drag force and the surface energy. In a typical scenario, a droplet enters the fusion region with surface modification, slows down and stops. It will wait and merge with subsequent droplet until the surface energy stabilization is overwhelmed by the viscous drag force.

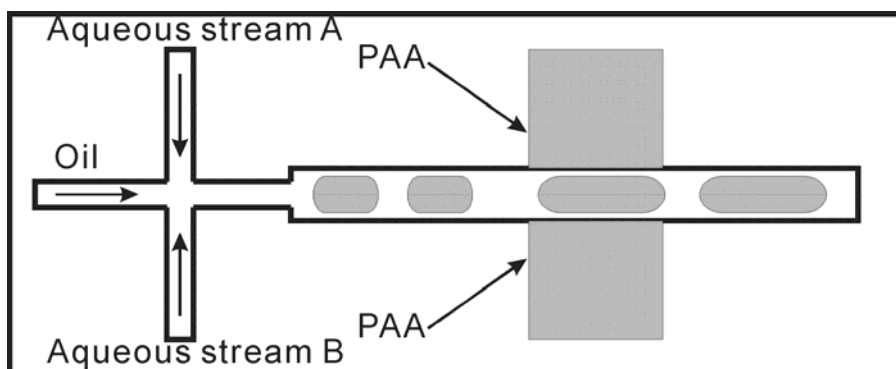

Fig. (6). Schematic illustration of surface-induced droplet fusion device

3. Active droplet coalescence

Electrocoalescence (EC)

Electrocoalescence is an active method which is widely used to realize droplet fusion in the presence of an electric field. Electrocoalescence of microfluidic droplets was firstly presented by Chabert et al. [18]. Droplet fusion by alternating current (AC) field electrocoalescence was achieved. In order to realize electrocoalescence, the conductivity of the droplets needs to be much higher than that of the continuous phase. In the presence of an electric field, the effect of the droplets can be deemed as dipolar disturbances situated at the droplet centers. When the two droplets approach each other, a Columbic force which is proportional to the square of the applied electric field will attract the two droplets to achieve electrocoalescence.

Link et al. [19] demonstrated the concept of electrocoalescence by polarizing droplets through applying an direct current (DC) field as shown in Fig. (7). The water stream behave as a conductor, whereas the oil stream behave as a insulator. Under the applied electric field, upper and lower droplet will carry opposite charges. As the two droplets come close at the T-junction, they will attract each other. Subsequently, droplet fusion will take place. Based on this experiment, Sarrazin et al. [20] studied the mixing characteristics with different angle bends along the microchannel. The forty-five angle bends was found to be most effective for droplet mixing. Zagnoni et al. [21] investigated electrocoalescence mechanism of micro-droplets using localized electric fields. The localized electric system was found to be effective in merging droplets regardless of the distance between them. The viscosity of the continuous phase was found to be a dominant factor in electrocoalescence.

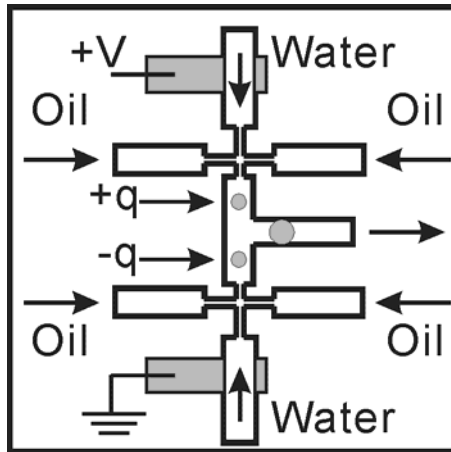

Fig. (7). Schematic illustration of electrocoalescence of droplets by applying an electric field through the aqueous stream

Based on the electrocoalescence microfluidic system, a novel merging element combining the advantages of passive and active merging approaches was proposed [22] as shown in Fig. (8). Pillar arrays and electrodes were employed as passive and active merging element respectively. The pillar array plays a role in slowing down and trapping the coming droplet through the drainage of the continuous phase. As the two subsequent droplets approach each other, an electric field will be applied to the electrodes. As soon as the applied electric field, the thin oil film around the droplets will be removed.

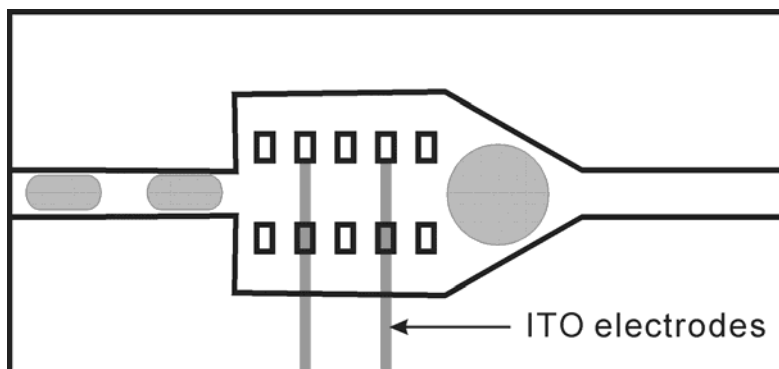

Fig. (8). Schematic illustration of the merging chamber with pillar arrays and embedded electrodes

The electrocoalescence of droplet population and their upstream cascade are investigated [23] as shown in Fig. (9). The upstream cascade can be described as a

two-stage mechanism. For the first stage, droplet fusion activated by the electric field only occurs in the adjacent of electrodes. For higher applied voltage, droplet fusion will occurs at the upstream of the electrodes. The fused large droplet will cause an imbalance in the curvature along the droplet interface. This imbalance will lead to the second stage which is described as upstream cascade. Under the effect of the large droplet formed at the first stage, a localized decompression will occur between adjacent droplets. As a result, upstream coalescence will take place. The phenomenon was found to be dependent on droplet size and distribution.

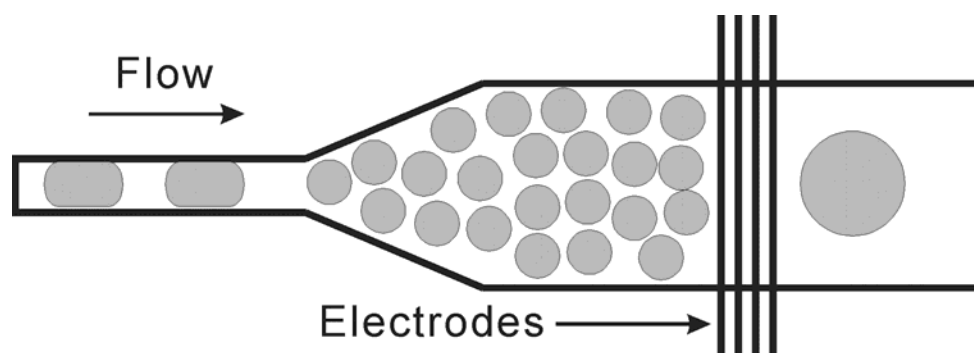

Fig. (9). Schematic illustration of the electrocoalescence behavior of a stream of water droplets under the effect of an applied electric field

In the above study, droplet generation and fusion are carried in subsequent steps. Wang et al. developed a microfluidic device to generate and merge two droplets at the same time [24]. The schematic illustration of the microfluidic devices is shown in Fig. (10). A double T-junction with a pair of embedded Pt wire and indium tin oxide (ITO) electrodes is employed as a microfluidic platform. Without an applied electric field between the ITO and Pt wire, an alternating droplet generation will be achieved as discussed before. When a DC voltage is applied across the ITO electrode and the Pt wires, a non-uniform electric field is built around the tip of the Pt wire. As a result, the water-oil interface will be polarized. Incoming two aqueous streams will be attracted at the tip of the Pt wire. Meanwhile, the two aqueous streams will merge together followed by the compound droplet generation.

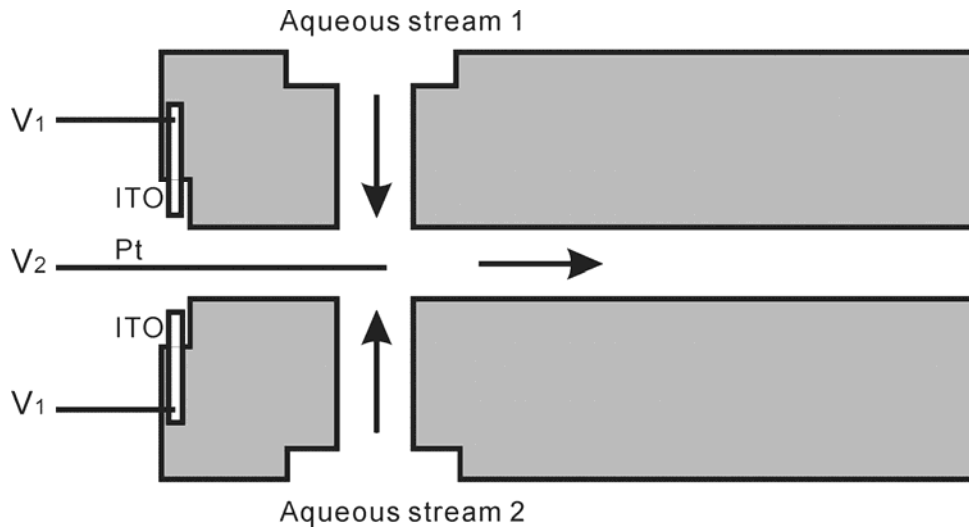

Fig. (10). Schematic illustration of microfluidic channel and electrode positions

Dielectrophoresis (DEP) actuated droplet coalescence

Similar to electrocoalescence, dielectrophoresis is also an effective way to realize droplet fusion. The key difference between DEP and EC is that DEP can only occur in a non-uniform applied electric field, while EC can occur in both uniform and non-uniform applied electric field [18]. DEP relies on the different dielectric constant between the droplet and the surrounding medium, while EC relies on the different conductivity of droplet and the continuous phase. Droplet manipulation through DEP was demonstrated by Schwartz et al [25-27]. In a typical scenario, an electric stress will act on a droplet surface which is subjected to a non-uniform electric field. A net electric force which is referred as DEP force will cause the motion of the droplet.

Temperature actuated droplet coalescence

Beside electrically induced droplet coalescence, thermally induced droplet coalescence is also an effective method. The mechanism of this method is to exploit temperature-dependent viscosity and surface tension. On the one hand, increasing temperature leads to a decrease in viscosity of the continuous phase. As a result, the continuous phase flows faster due to the heating effect. On the other hand, the surface tension of the droplet will decrease as temperature increases, therefore droplet fusion

process can take place more easily.

Temperature actuated droplet coalescence was demonstrated by Kohler et al [13]. Thermally controlled droplet fusion in a microfluidic device is shown in Fig. (11). A high fluid resistance element was incorporated with a long channel with reduced cross section. A thin film heater was embedded within the high fluid resistance element. As fluid flow over this channel, a portion of continuous phase will go through the small channel with high fluid resistance. As the thin film heater is activated, the temperature in the small channel with high fluid resistance also increases, the viscosity of continuous phase will decrease, more and more continuous phase will go through the small channel. With the drainage of continuous phase in the main channel, subsequent droplets will have a chance to approach each other. When droplet fusion occurs, the heater is turned off to let the fused droplet go through the channel.

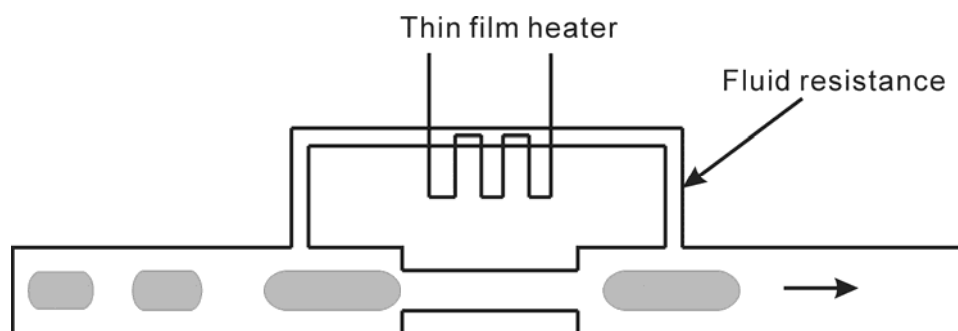

Fig. (11). Schematic illustration of thermally controlled droplet fusion microfluidic device

Instead of using a thin film heater, a focused laser is employed to provide heating function to fuse droplets as shown in Fig. (12) [28, 29]. Without the activation of the focused laser, a train of droplets are neatly aligned in the microchannel. Although they are in contact with each other, droplet coalescence can not be achieved because of a thin film between them. The presence of surfactant molecules on an oil-water interface is known to stabilize droplets against fusion [30]. With the activation of the focused laser, localized heating from the focused laser will be induced. A spatial variation of temperature field builds up resulting in a spatial imbalance of surface

tension. A net force is produced on the droplet interface through the thermocapillary effect. Under this net force, the surfactant molecules and the lubrication film will be evacuated. After that, the two subsequent droplets can merge together. With the developing of optical techniques, a generalized phase contrast (GPC) method is proposed to allow a single focused laser to be divided into many laser spots which can be independently manipulated [31]. A schematic illustration of a GPC light shaping box is shown in Fig. (13). After beam modulation and beam separation, a focused laser can be divided into many laser spots. This technique could potentially be used for droplet manipulation at different desired locations.

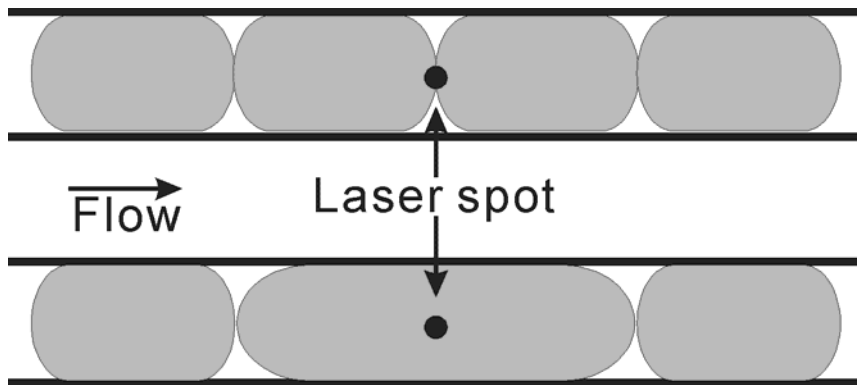

Fig. (12). Schematic illustration of localized fusion of droplets

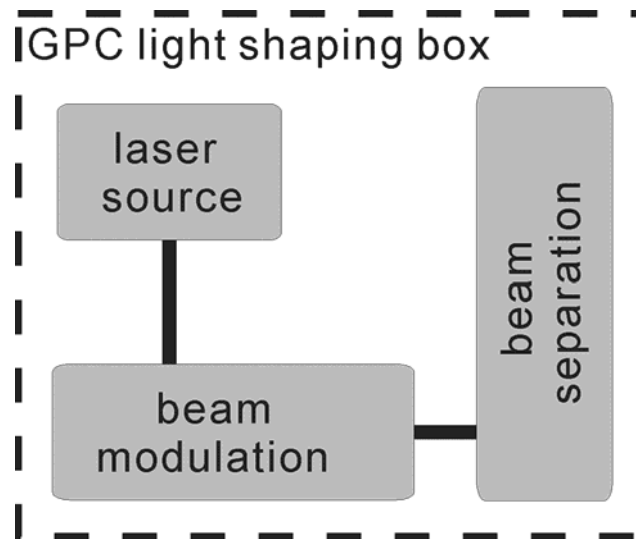

Fig. (13). Schematic illustration of a GPC light shaping box

Pneumatically actuated droplet coalescence

Another method for the active merging of droplets is pneumatically actuated

droplet coalescence [32] . In such an active merging device, a pneumatically actuated membrane valve is constructed on the top of the merging chamber as shown in Fig. (14). As the droplet comes into the merging chamber, the membrane valve is activated and plays a role as a blockage to impede the droplet motion. The droplet slows down and waits for the subsequent droplet in the waiting zone. The subsequent droplet driven by the continuous phase will continue to push the former droplet moving further into the waiting zone. As they approach to each other, droplet fusion takes places. As the desired droplet fusion is achieved, the pneumatically actuated membrane valve will open to let the fused droplet to get out.

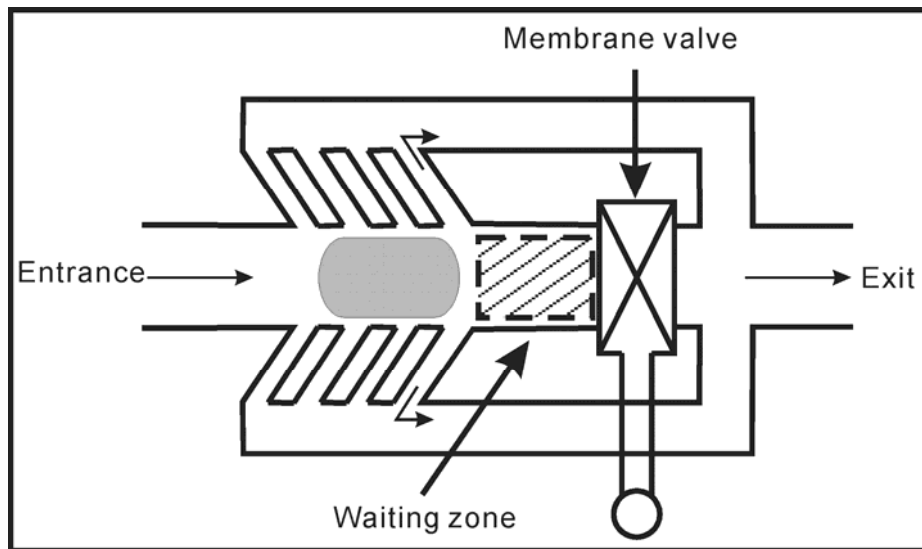

Fig. (14). Schematic illustration of pneumatically actuated droplet fusion device

4. Conclusions

This paper reviews the different methods for droplet coalescence. In the early development stages, passive droplet merging devices embedded with a fluid resistance element have been improved to be effective in achieving droplet synchronization. Many researchers focused on passive droplet merging devices due to its simple fabrication processes. With the development of the micro technology, an increasing number of active droplet merging methods were proposed and reported. Under active droplet merging methods, droplet coalescence can be achieved for different requirements. A simple but more effective active droplet fusion device is

needed for practical applications.

References

1. Thorsen, T., et al., Dynamic pattern formation in a vesicle-generating microfluidic device. *Phys. Rev. Lett.* **2001**, *86* (18), 4163-4166.
2. Handique, K. and M.A. Burns, Mathematical modeling of drop mixing in a slit-type microchannel. *J. Micromech. Microeng.* **2001**, *11* (5), 548-554.
3. Trachsel, F., et al., Measurement of residence time distribution in microfluidic systems. *Chem. Eng. Sci.* **2005**, *60* (21), 5729-5737.
4. Song, H., D.L. Chen, and R.F. Ismagilov, Reactions in droplets in microfluidic channels. *Angew. Chem. Int. Ed.* **2006**, *45* (44), 7336-7356.
5. Nguyen, N.T. and Z. Wu, Micromixers - A review. *J. Micromech. Microeng.* **2005**, *15* (2).
6. Guttenberg, Z., et al., Planar chip device for PCR and hybridization with surface acoustic wave pump. *Lab Chip* **2005**, *5* (3), 308-317.
7. Zheng, B., L.S. Roach, and R.F. Ismagilov, Screening of protein crystallization conditions on a microfluidic chip using nanoliter-size droplets. *J. Am. Chem. Soc.* **2003**, *125* (37), 11170-11171.
8. Srinivasan, V., V.K. Pamula, and R.B. Fair, An integrated digital microfluidic lab-on-a-chip for clinical diagnostics on human physiological fluids. *Lab Chip* **2004**, *4* (4), 310-315.
9. Riegler, H. and P. Lazar, Delayed Coalescence Behavior of Droplets with Completely Miscible Liquids. *Langmuir* **2008**, *24* (13), 6395-6398.
10. Tan, Y.C., et al., Design of microfluidic channel geometries for the control of droplet volume, chemical concentration, and sorting. *Lab Chip* **2004**, *4* (4), 292-298.
11. Eggers, J., J.R. Lister, and H.A. Stone, Coalescence of liquid drops. *J. Fluid Mech.* **1999**, *401*, 293-310.
12. Fidalgo, L.M., C. Abell, and W.T.S. Huck, Surface-induced droplet fusion in microfluidic devices. *Lab Chip* **2007**, *7* (8), 984-986.
13. Köhler, J.M., et al., Digital reaction technology by micro segmented flow - components, concepts and applications. *Chem. Eng. J.* **2004**, *101* (1-3), 201-216.
14. Chokkalingam, V., et al., Optimized droplet-based microfluidics scheme for sol-gel reactions. *Lab Chip* **2010**, *10* (13), 1700-1705.
15. Bremond, N., A.R. Thiam, and J. Bibette, Decompressing emulsion droplets favors coalescence. *Phys. Rev. Lett.* **2008**, *100* (2).
16. Hung, L.H., et al., Alternating droplet generation and controlled dynamic droplet fusion in microfluidic device for CdS nanoparticle synthesis. *Lab Chip* **2006**, *6* (2), 174-178.
17. Niu, X., et al., Pillar-induced droplet merging in microfluidic circuits. *Lab Chip* **2008**, *8* (11), 1837-1841.
18. Chabert, M., K.D. Dorfman, and J.L. Viovy, Droplet fusion by alternating current (AC) field electrocoalescence in microchannels. *Electrophoresis* **2005**, *26* (19), 3706-3715.
19. Link, D.R., et al., Electric control of droplets in microfluidic devices. *Angew. Chem. Int. Ed.*

- 2006**, *45* (16), 2556-2560.
20. Sarrazin, F., et al., Mixing characterization inside microdroplets engineered on a microcoalescer. *Chem. Eng. Sci.* **2007**, *62* (4), 1042-1048.
 21. Zagnoni, M., G. Le Lain, and J.M. Cooper, Electrocoalescence mechanisms of microdroplets using localized electric fields in microfluidic channels. *Langmuir* **2010**, *26* (18), 14443-14449.
 22. Niu, X., et al., Electro-coalescence of digitally controlled droplets. *Anal. Chem.* **2009**, *81* (17), 7321-7325.
 23. Zagnoni, M., C.N. Baroud, and J.M. Cooper, Electrically initiated upstream coalescence cascade of droplets in a microfluidic flow. *Phys. Rev. E: Stat. Nonlinear Soft Matter Phys.* **2009**, *80* (4).
 24. Wang, W., C. Yang, and C.M. Li, Efficient on-demand compound droplet formation: from microfluidics to microdroplets as miniaturized laboratories. *Small Mol.* **2009**, *5* (10), 1149-1152.
 25. Schwartz, J.A., J.V. Vykoukal, and P.R.C. Gascoyne, Droplet-based chemistry on a programmable micro-chip. *Lab Chip* **2004**, *4* (1), 11-17.
 26. Singh, P. and N. Aubry, Transport and deformation of droplets in a microdevice using dielectrophoresis. *Electrophoresis* **2007**, *28* (4), 644-657.
 27. Wang, W., C. Yang, and C.M. Li, On-demand microfluidic droplet trapping and fusion for on-chip static droplet assays. *Lab Chip* **2009**, *9* (11), 1504-1506.
 28. Baroud, C.N., M. Robert De Saint Vincent, and J.P. Delville, An optical toolbox for total control of droplet microfluidics. *Lab Chip* **2007**, *7* (8), 1029-1033.
 29. Lorenz, R.M., et al., Vortex-Trap-Induced Fusion of Femtoliter-Volume Aqueous Droplets. *Anal. Chem.* **2006**, *79* (1), 224-228.
 30. Amarouchene, Y., G. Cristobal, and H. Kellay, Noncoalescing drops. *Phys. Rev. Lett.* **2001**, *87* (20), 206104/1-206104/4.
 31. Perch-Nielsen, I.R., et al., Autonomous and 3D real-time multi-beam manipulation in a microfluidic environment. *Opt. Express* **2006**, *14* (25), 12199-12205.
 32. Lin, B.C. and Y.C. Su, On-demand liquid-in-liquid droplet metering and fusion utilizing pneumatically actuated membrane valves. *J. Micromech. Microeng.* **2008**, *18* (11).