

Evaluation of alternative water sources for commercial buildings: a case study in Brisbane, Australia

Author

Cook, Stephen, Sharma, Ashok K, Gurung, Thulo Ram

Published

2014

Journal Title

Resources, Conservation & Recycling

DOI

[10.1016/j.resconrec.2014.05.003](https://doi.org/10.1016/j.resconrec.2014.05.003)

Rights statement

© 2014 Elsevier B.V.. This is the author-manuscript version of this paper. Reproduced in accordance with the copyright policy of the publisher. Please refer to the journal's website for access to the definitive, published version.

Downloaded from

<http://hdl.handle.net/10072/62279>

Griffith Research Online

<https://research-repository.griffith.edu.au>

Please cite this as:

Cook, S., Sharma, A.K., Gurung T.R. (2014) Evaluation of alternative water sources for commercial buildings: a case study in Brisbane, Australia. *Resources, Conservation and Recycling*, Vol. 89, pp.86-93, DOI: <http://dx.doi.org/10.1016/j.resconrec.2014.05.003>

Evaluation of alternative water sources for commercial buildings: a case study in Brisbane, Australia

Stephen Cook^{1*}, Ashok Sharma¹, and Thulo Ram Gurung^{2,3}

¹*CSIRO Land and Water Australia, Highett, Vic 3190, Australia*

²*CSIRO Land and Water Australia, Dutton Park, Qld, 4102, Australia*

³*School of Engineering, Griffith University, Gold Coast Campus, Qld 4222, Australia*

* Corresponding author: Stephen.cook@csiro.au or +61 3 9252 6603

Highlights

- Provides a framework for investigating and validating the performance of local, non-potable water sources.
- Validates the performance of different alternative water sources in conserving mains drinking water in commercial buildings.
- Explores the factors that impede the sustainability of decentralised water systems.
- Proposes an integrated approach to assessing the feasibility of water serving options in commercial buildings.

Evaluation of alternative water sources for commercial buildings: a case study in Brisbane, Australia

Commercial buildings are central to cities and contribute significantly to the urban demand for natural resources, including freshwater. Green building benchmarking tools include more efficient water use as key indicator of sustainability. This paper explores options for substituting mains drinking water with an alternative, non-potable water source on a fit for purpose basis. The research findings are based on a monitoring study of a commercial building in Brisbane, Australia that is harvesting rainwater for meeting non-potable water demand. The results demonstrated that the system is only achieving moderate reliability in meeting demand due to operational problems. The case study analysis has highlighted the need to include validation and monitoring to ensure the system is operating as per design intent. The paper also investigates the potential of other local, non-potable water sources for high-rise commercial buildings, in particular air conditioning condensate and groundwater inflow to a basement wet well. The paper concludes by comparing the advantages and disadvantages of different local water sources which highlights the need to undertake a site specific investigation to identify a suitable alternative water source, which considers O&M complexity and the capacity of facilities management.

Keywords: water conservation; water supply substitution; rainwater harvesting; alternative water sources; green buildings; ecologically sustainable development

1. Introduction and background

Commercial water use is a significant component of overall urban water demand. In Australia commercial water use makes up around 15% of the total demand for urban water (ABS, 2010). Water audits of commercial office buildings have revealed that non-potable applications, in particular for toilet flushing and cooling tower blowdown, accounts for between 50% and 90% of total building water demand (Seneviratne, 2006). The influence of office buildings on the urban form of cities means there is need to incorporate this sector in seeking more sustainable development (Burnett, 2007). This

includes exploring opportunities for conservation of mains drinking water through substitution with alternative water sources.

The need to explore alternative water sources in cities is being driven by uncertainty in the future reliability of traditional water supply sources due to climate change impacts and growing demand from increasing urban populations (Ruth et al. , 2007, Sharma et al. , 2012). However, a lack of reported monitoring studies on the performance of alternative water servicing options against sustainability objectives has impeded mainstream adoption in the development sector (Sharma et al. , 2012).

The role of alternative local water sources in reducing demand for imported potable water and reducing the environmental impact of urban development has received considerable attention in the residential sector from both researchers and policy makers (Imteaz et al. , 2013, Jones and Hunt, 2010, Khastagir and Jayasuriya, 2010), but there are limited studies that report on the implementation of alternative water sources for commercial buildings (Ward et al. , 2012). Notable exceptions include: Chilton et al. (2000) who evaluated the performance and value proposition of a scheme that harvested runoff from a supermarket roof for toilet flushing, while Imteaz et al. (2011) detailed the optimisation of storage tank sizes for a system harvesting roof runoff from large roofs at a university campus, which was used for landscape irrigation. Zhang et al. (2009) provided a comparative assessment of using rainwater or greywater for reducing mains water demand in a high-rise building. Their assessment found that greywater provided a more suitable source due to the constant supply when compared to the episodic nature of rainfall events.

This paper – based on a monitoring study of a commercial building in Brisbane, Australia – provides a case study analysis on the reliability of roof-harvested rainwater in meeting non-potable demand, and the pumping energy required. This paper also

explores other potential non-potable water sources for commercial buildings in terms of yield and quality while also taking into account energy and life cycle costs. The complexities of managing and operating decentralised water systems are also considered.

1.1 Water use in commercial buildings and drivers for efficiency

Minimising mains water use through source substitution is part of a broader shift in cities to improve the environmental performance of the built environment through Ecologically Sustainable Development (ESD) (Najia and Lustig, 2006).

The drivers for incorporating sustainability initiatives are both top-down and bottom-up (Newell., 2008). Top-down drivers for ESD in the commercial development sector include regulation through building codes and legislation, and also rising costs for utility services. While, bottom-up drivers include corporate sustainability objectives, marketability of sustainable buildings, and the introduction of industry rating schemes that benchmark the sustainability performance of a building (Newell., 2008). In Australia the Green Building Council introduced the Green Star Rating, with analogous sustainability benchmarking schemes in other countries including BREEAM in the United Kingdom and LEED in the United States (Wang et al. , 2010). Drivers such as sustainable benchmarking are providing the impetus for the commercial development sector to incorporate ESD initiatives, such as source substitution with alternative water sources. However, there is uncertainty about the performance of alternative water systems and their contribution to improved sustainability in green buildings (Wedding and Crawford-Brown, 2007). In encouraging the wider adoption of alternative water systems, there is a need to validate their performance so that lessons can be applied in future developments (Cook et al. , 2013). More monitoring and evaluation of existing

alternative water systems can enable evidence-based benchmarking of performance for similar buildings and inform improved design guidelines.

2. Methodology

Figure 1 summarises the key steps of the methodology. The research was grounded in the monitoring study of a rainwater system that supplied non-potable demand in a commercial office building. This primary data collection and analysis provided a foundation for considering overall performance of the rainwater harvesting system in reducing demand for mains drinking water. The research included consideration of social aspects through interviews with the building owners, the designers of the rainwater system and the building facility managers. The interviews focussed on the issues experienced with the implementation and operation and maintenance of the rainwater harvesting scheme. The technical feasibility of other non-potable water sources were assessed in terms of their ability to provide cost effective solutions that maximise mains water savings, while minimising adverse environmental impacts and considering user operating requirements. The application of the methodology provided a basis for assessing the relative strengths and weaknesses of different local water sources, and how a combinatorial approach may provide the best outcome for meeting local non-potable water demand.

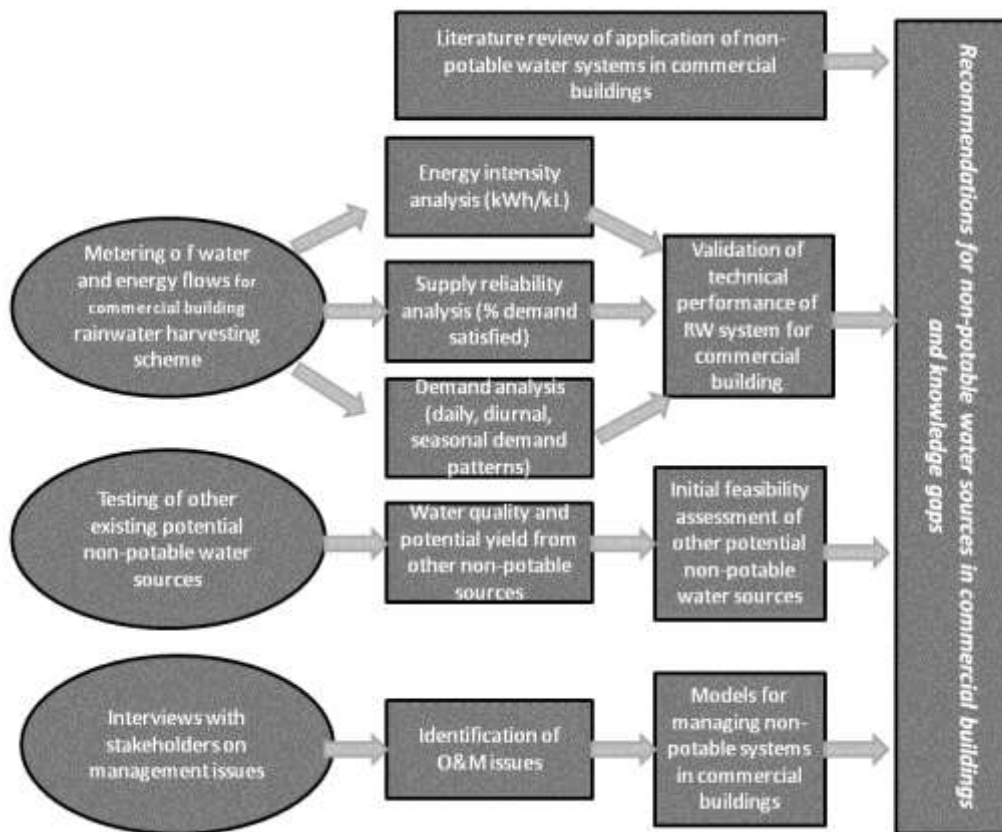

Figure 1. Methodology for validation of rainwater harvesting for a commercial building and comparative analysis with other non-potable water sources

2.1 Case study

The case study building, Green Square North Tower (GSNT), is located in Fortitude Valley, which forms part of the central business district of Brisbane, Australia. GSNT is a twelve storey commercial office building that was designed to meet a 6 star standard under the Green Star Rating scheme (Steinfeld et al. , 2011). The initiatives for mains water conservation included waterless urinals and the harvesting of roof runoff for substituting mains water for toilet flushing and landscape irrigation demands. Figure 2 depicts the hydraulic circuit of the GSNT rainwater system, and the metering system that was used to validate the reliability of the system in meeting non-potable demand, and the associated pumping energy demand. Rainwater was harvested from an effective roof area of approximately 1,600 m² then gravity fed via downpipes to a 110 m³

basement storage tank. The water in the basement tank was then pumped back to the roof to two smaller tanks (21m³ and 28 m³) that were used to satisfy toilet flushing and garden irrigation respectively, with gravity feed to points of use. The header tanks had pressure floats, so that when the water level fell to the low-level float a pressure switch activated pumping from the basement tank. In the case of the toilet tank, there was back-up supply from the mains water if demand could not be satisfied by harvested rainwater. Overflow from the basement rainwater tank, following heavy rainfall events, was directed to a wet well where it was then pumped for discharge to the stormwater drain.

The toilet tank was used to satisfy the demand for flushing of 147 toilets that had full and half flushes, with an estimated water efficiency of 6 litres for a full flush and 3.8 litres per half flush. The irrigation tank was used for watering window planter boxes; however the area under irrigation was small, so the water demand was negligible. The occupancy of GSNT was estimated at 1,200 workers based on office floor space of 24,000 m² and a density of 20 m² per worker (Saari et al. , 2006).

GSNT is located in a sub-tropical climate zone where the annual rainfall is around 1,000 millimetres (Bureau of Meteorology, 2013). The rainfall distribution over the year is marked by distinct wet and dry seasons.

2.2 Monitoring System

Monitoring of energy and water fluxes at GSNT was undertaken using a high-frequency logging device that recorded water flows and energy pulses at each 6-minute time interval. A data logging system stored the data in 6-minute, hourly and daily data files. Manual recordings taken monthly from the water and energy meters were used to calibrate the electronically logged data.

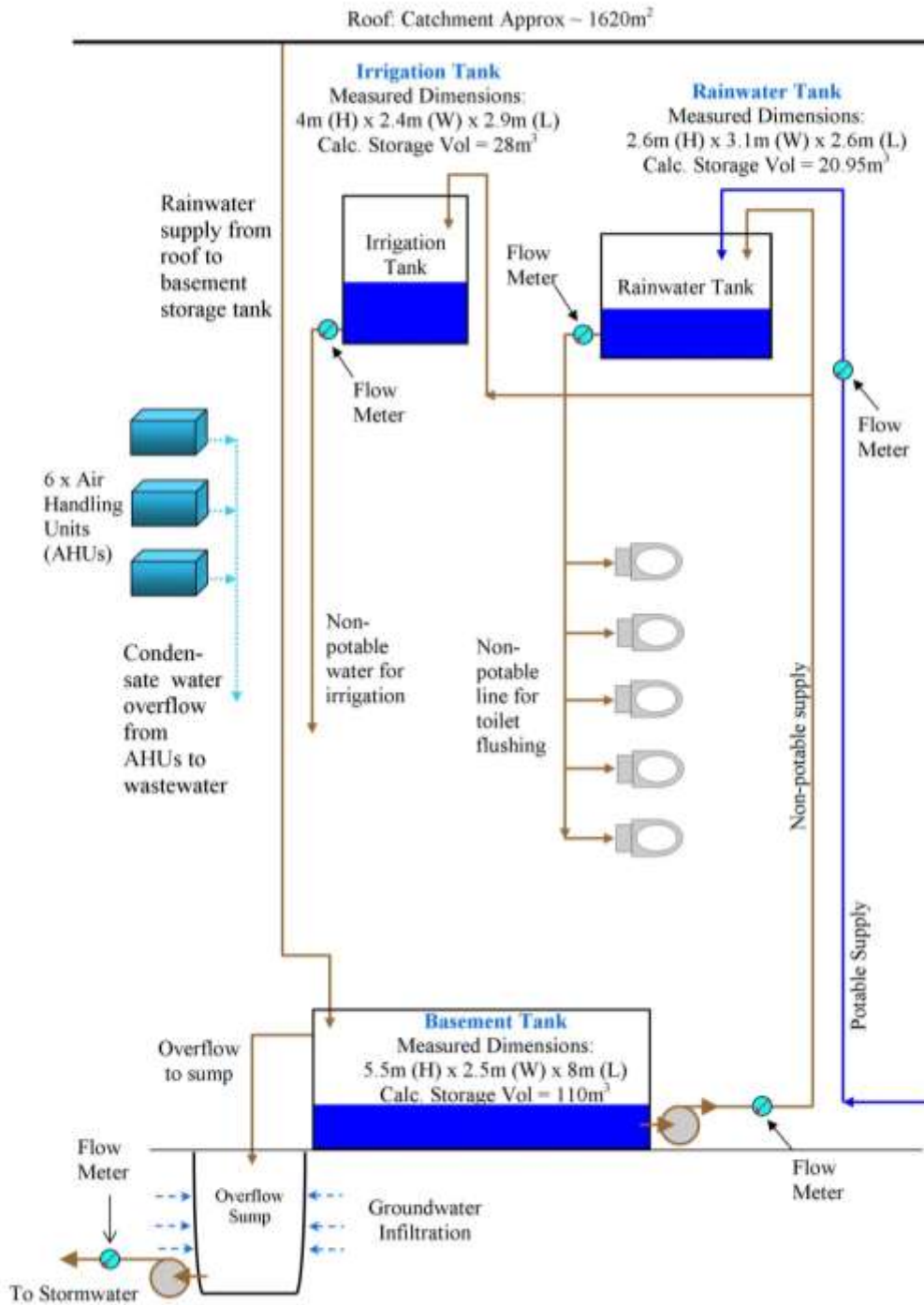

Figure 2. Hydraulic circuit of Green Square North Tower rainwater harvesting system

3. Results

Table 1 summarises the rainwater yield and energy intensity of the GSNT system over the 26 month monitoring period. This showed that the system could be characterised as

fair to moderate level of reliability, as only 37% of the non-potable demand was satisfied by harvested rainwater. However, the system delivered water supply at a low energy intensity. The demand for toilet flushing was around 7.8 kL per day. This equated to around 54 litres per day for each of the 146 toilets or 15 flushes per day (3.5 litre average flush volume). There was minimal demand for irrigation due to the limited potential application and also the relatively high rainfall over this period.

Table 1. GSNT Rainwater scheme yield and energy demand (monitoring period March 2010 to April 2012)

Supply and Demand	Daily Average
Demand for Toilet roof tank	7.8 kL/day
Demand for irrigation tank (no potable top-up)	0.7 kL/day
Overall demand for non-potable system	8.5 kL/day
Rainwater supplied from basement tank	3.2 kL/day
Top-up to toilet flushing roof-top tank from municipal supply	5.3 kL/day
Specific Energy for Rainwater System	Specific Energy
Energy for rainwater system (pumping rainwater from basement tank)	0.44 kWh/kL

During the monitoring period, it was noticed that at times there was no or very irregular pumping from the basement to the header tank despite a relatively constant demand of around 8 kL per day. Investigations found a problem with a pressure switch, which was not activating pumping from the basement tank when the level in the header tank fell to the low-level mark. Figure 3 depicts hour demand and supply data for the non-potable system over an eight day period (which included a public holiday). This shows there was a reasonably consistent demand pattern over the working days. Despite the storage

tank being full, however, no demand was being drawn from the tank, which meant that supply was being met through mains water top-up to the header tank. This pattern of no pumping from the basement tank was observable for many periods during the monitoring. Figure 4 depicts the average and maximum water demand for toilet flushing (non-working days - weekends and public holidays - were excluded from the data as the building was not occupied on those days). As expected the diurnal demand pattern reflects the average working day, with highest demand between 9 AM and 4 PM. The maximum hourly demand varied from the average hourly demand by up to 3 times.

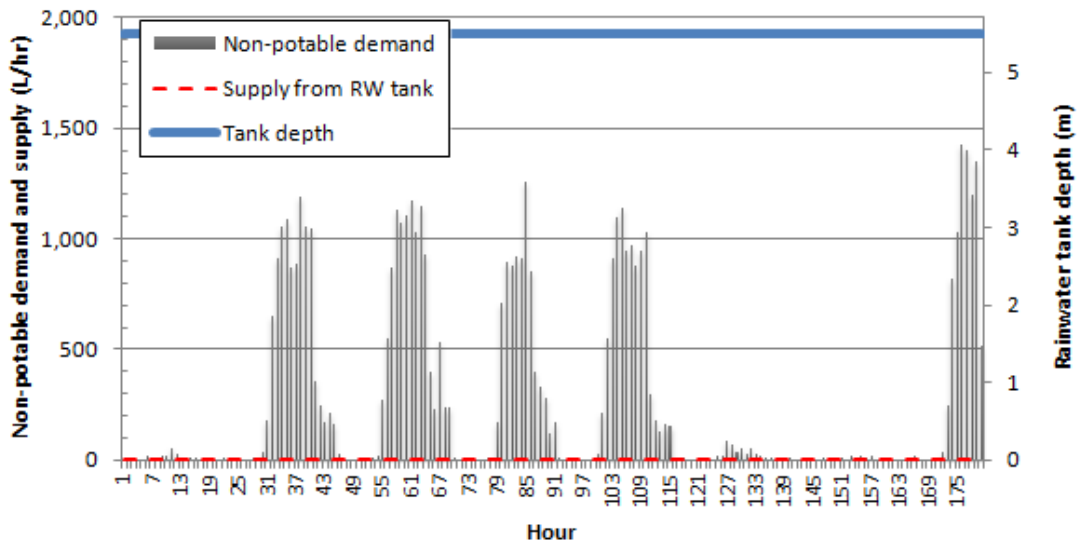

Figure 3. Pumping from basement tank

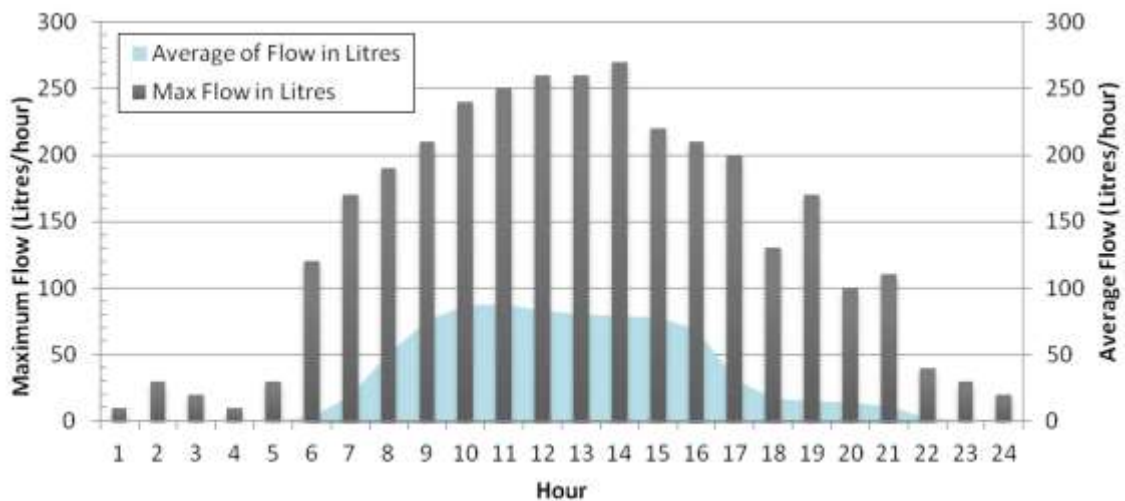

Figure 4. Average and maximum hourly (work days) toilet flushing water demand

3.1 Alternative sources

Two additional non-potable, local water sources were also investigated to determine their potential to supply non-potable water demand at GSNT. The two sources investigated were: groundwater flows to a wet well that was then pumped to stormwater system and condensate from air handling units that was part of the air conditioning system for GSNT.

Condensate from air handling units

Air handling units (AHU) produce condensate as part of their normal operations, which typically drain to municipal sewer systems. Condensate has been used in industrial and commercial buildings as it provides a relatively good quality non-potable water source with no additional treatment required (i.e. no energy requirements) (Licina and Sekhar, 2012). Examples where condensate has been used as a non-potable water source include hospitals and for reuse in cooling towers (EPA, 2007). Condensation is a function of the temperature and relative humidity of the outside air, relative to the desired temperature and humidity in the building, and the amount of cooling provided.

The potential condensate that could be captured for non-potable reuse at GSNT was based on the following equation (Lawrence, 2010):

$$q_{cond} = q_{air} dw_{lb} / v_{da}$$

Where:

q_{cond} is condensate generated in litres per minute

q_{air} is air flow in cubic metres per minute

dw_{lb} is the difference in specific humidity

v_{da} is the specific volume of air

GSNT has six AHUs with a combined capacity of 234 kW. Discussions with building managers revealed that the AHU's operate on working days for approximately 10 hours.

Time-proportional water quantity sampling was undertaken to validate the potential condensate yield. The five minute tests were done in October when the outside temperature was 25 °C and a relative humidity of 75%. The 5 minute sampling revealed condensate yields of between 6 and 11 litres per minute. At this rate, around 6.5 kL of condensate could be generated for a 10 hour operating period. However, as the yield is dependent upon changes in outside temperature and humidity there was a need to consider daily and seasonal variation in the likely condensate yield. Figure 5 depicts the mean monthly temperature and relative humidity for Brisbane.

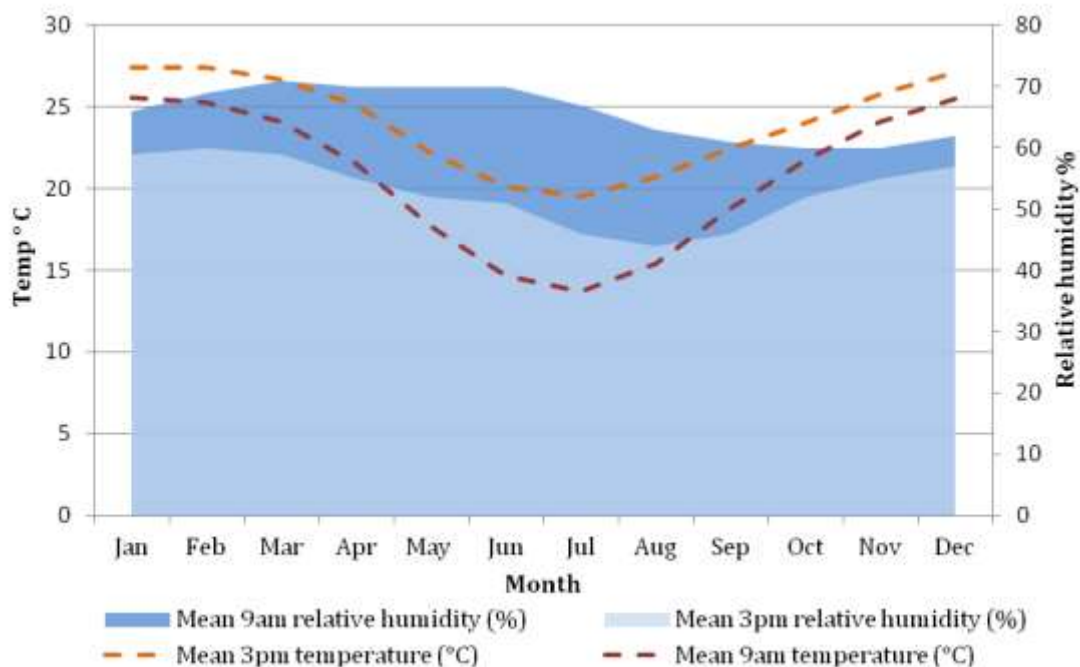

Figure 5 – Brisbane: Mean 9 AM and 3 PM temperature and relative humidity

The following assumptions were made on the operation of AHUs at GSNT in estimating the rate of condensate at different times of the year: operated 8 AM to 6 PM for 220 working days per year, conditioned air delivered at a temperature of 21°C and a relative humidity of 40%. These values were based on the *ASHRAE Standard 55 - 2010 Thermal Environmental Conditions for Human Occupancy* (ASHRAE, 2010). It was

also assumed 20% of the air passing through the AHUs was outdoor air, with the remainder re-circulating air.

Figure 6 depicts the theoretical condensate rate for GSNT based on mean temperature and relative humidity at 9 AM and 3PM. These two time points were used as climate observations from the weather station are recorded at these times. Figure 6 shows that there was marginal variation in the condensate rate between 9 AM and 3 pm conditions for each month, but significant variation in the average monthly condensate rates. The analysis showed that for Brisbane conditions, the potential yield from condensate would be negligible during the cooler winter months (approx. 270 litres per day in July – assuming AHUs operating for 10 hours) but could be a very significant non-potable water source during the warmer summer months (approx. 4,200 litres per day in January).

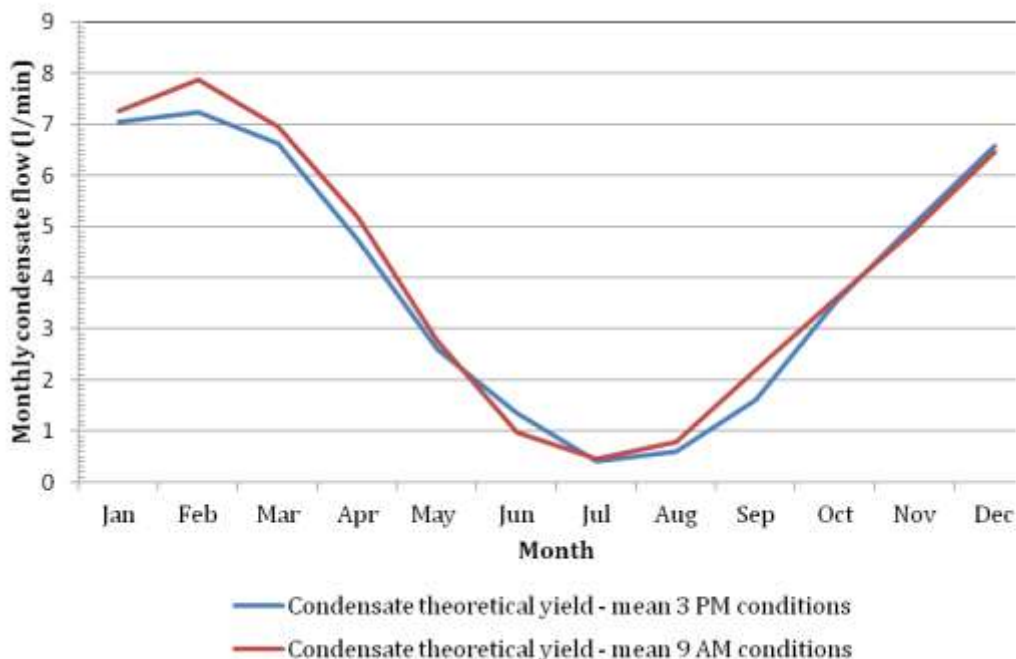

Figure 6 - Theoretical monthly condensate rate at GSNT

The annual peak for the potential supply of condensate coincides with the peak demand for outdoor irrigation during the warmer summer months. Therefore, the results indicated that condensate harvesting in commercial buildings is only suited to relatively hot and humid climates that have a matching non-potable demand. For the Brisbane climate at GSNT, the potential reliability of condensate for toilet flushing, which is a constant non-seasonal demand, was limited as supply during winter months would be less than 5% of the demand.

Reuse of groundwater inflow

Groundwater controls are often needed both during the construction of high rise buildings and during their operating life to manage the impact of groundwater inflows on the stability of soils. In particular, dewatering is often required when the foundations of building extend into the saturated soil zone.

GSNT was built on *Brisbane Tuff* geological formation which was formed during the late Triassic and is comprised of welded tuff, sandstone with shales and conglomerate near the base of the unit (Queensland Government, 2008). Groundwater flows through this unit occur through defects in the bedrock, such as fractures, joints and bedding planes. The groundwater depths and flows through this unit are highly variable as they are governed by the nature of the defects. The depth to groundwater in this geological formation, near GSNT, were found to vary significantly within a relatively small area, with field investigations at nearby site finding that groundwater table depth ranged from 1 to 11 metres (Queensland Government, 2008). It is also considered likely that groundwater inflows in this area are influenced by tides due to the proximity of the lower reaches of the Brisbane River (Queensland Government, 2008).

Groundwater inflow to the basement at GSNT is collected in a wet well and then pumped for discharge to the municipal stormwater system. Flows to the wet well also

include overflows from the rainwater tank during high rainfall events. Pumping from the wet well was monitored over a year, with data collected at 6 minute time intervals. There was a period when the data logging system was not operational so the monitoring data is non-continuous. Figure 7 depicts the daily volume pumped from the wet well to the stormwater drain, which shows that there was a steady 5 to 6 kL discharged per day, which represents around 75% of the daily demand for toilet flushing. Even when there was no rainfall over the antecedent 20 days, the volume pumped from the wet well was consistently more than 5 kL a day, which indicated groundwater inflow. There were periods of very high pumping from the wet well which were associated with extreme rainfall events, as shown in Figure 7.

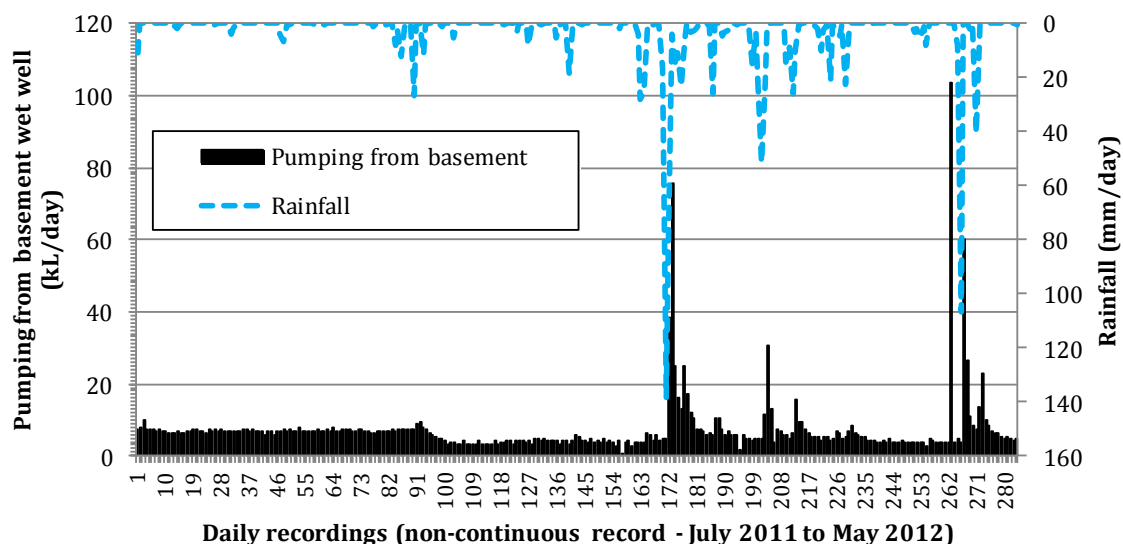

Figure 7 – Daily pumping volumes and rainfall depth

Water Quality of Alternative Sources

Table 2 compares the water quality of alternative water sources available to the GSNT building. The sampling was undertaken once, so it provides an indicative snapshot of water quality characteristics. The AHU condensate and rainwater both provide a high quality of water source that is suitable, without prior treatment, as non-potable water

sources for toilet flushing. However, the groundwater inflow can be classified as hard, which may lead to potential problems with corrosion and scaling in metallic pipes (WHO, 2011). This may limit the potential application of untreated groundwater at GSNT, and indicates that groundwater quality testing would need to be the first step in considering its potential use in commercial buildings. The hardness of the groundwater could be managed through the use of non-metallic pipes, or the installation of a water softener system.

While there was some evidence of microbiological contamination of the groundwater inflow and harvested rainwater, the fact that the intended use is only for toilet flushing means the risk exposure is low.

Table 2 - Water quality of GSNT alternative

Water Quality Parameter	Air handing unit condensate	Groundwater inflow	Rainwater	WHO Drinking water guideline values¹
pH	6.9	8.5	6.9	6.5 – 8.5*
Total dissolved solids (mg/L)	-	332	44	600*
Total hardness as Ca CO ₃ (mg/L)	< 1	136	16	-
Conductivity µS/cm	12	495	77	-
Lead (mg/L)	<0.2	<0.2	<0.2	0.01
Total Nitrogen (mg/L)	0.67	3.05	0.5	50
E. coli (cells/100 ml)	1	-	-	<1 per 100 mL

* Aesthetic guideline value only, - no guideline value

¹WHO (2011) Guidelines for drinking-water quality, World Health Organisation, Fourth edition.

System Operation and Maintenance

While the monitoring of the GSNT rainwater system showed that only moderate reliability was achieved there were extenuating circumstances, which are explored here. In undertaking the monitoring study, a number of technical and operational issues were identified that meant the rainwater system did not operate as per the design intent. The following is based on the authors' observations, and also interviews with key stakeholders, who were: engineering consultants involved in the design and implementation, representatives of the building owner – a listed property trust, and the facilities manager, who was responsible for the daily Operation and Maintenance (O&M) tasks at GSNT.

The system at GSNT experienced ongoing problems with the pressure switch that activated pumping from the basement tank. This meant for some months the toilet tank was being supplied with mains water, even though the basement tank was full. The system fault was identified through the analysis of the monitoring data, and then communicated to the building facilities manager, owner, and contractors to highlight and rectify the fault. In an interview the building manager noted that there was no way to monitor if rainwater was being used for toilet flushing or mains water without physical inspection of the tank levels. He suggested a simple monitoring system, which could use pressure transducers to show tanks levels, could be incorporated in the existing building management system. This type of monitoring would be able to rapidly highlight system faults and overall performance. Given the capital investment in alternative water systems to meet building sustainability benchmarks, the additional small investment to ensure system is operating correctly by electronic monitoring would be justified.

The design drawings of the non-potable system at GSNT indicated that other non-potable water sources would be captured to augment supply to the basement tank.

Specifically, these other water sources were air conditioning condensate, fire test water, and cooling tower blow-down. It was the understanding of building manager and the authors that these sources were being used. However, the analysis of monitoring results challenged this assumption, as there were no flows to the basement tank during extended periods of no rainfall. Interviews with the engineering firms involved in the construction phase of the development revealed that original design intent was not followed through in construction due to uncertainties in water quality, so instead of contributing to the non-potable system these sources were discharged to wastewater. This highlights the need for post implementation validation of decentralised water system operation against design intent, as identified by Ward et al. (2012). This is particularly important to determine if the system is delivering against the sustainability objectives that were used to justify an alternative approach for water servicing in commercial buildings.

4. Discussion

In considering the role of alternative water sources in improving the sustainability of office buildings, there is the need to undertake an integrated assessment that compares supply augmentation with demand side measures. The assessment also needs to consider the implications of different water servicing options across social, economic and environmental objectives. The assessment of potential alternative water supply in commercial buildings needs to move beyond technical feasibility, and theoretical reliability, to take into account the specific context of the building in terms of local water source opportunities, and also the associated management complexities in maintaining and operating these systems. The technical skills and management burden needs to be aligned with the expectations and the capacity of the building managers and owners. Elmualim et al. (2010) highlighted that for facilities managers time constraints,

lack of knowledge and lack of management commitment are the greatest impediments to achieving more sustainable development.

The reliability of a non-potable water source for commercial buildings needs to consider the associated management burden and O&M complexities, as inadequate O&M is likely to increase failure rates.

5. Conclusions

Commercial buildings contribute significantly to the ecological footprint of urban areas so there is the need to consider opportunities for improved sustainability in this setting through more efficient use of water, energy and materials. The benchmarking of sustainability performance has provided the impetus for many commercial buildings to implement decentralised water servicing options to achieve best practice standards, however there remains a lack of monitoring studies to validate the performance of these systems against design sustainability objectives. This paper has reported on the performance of a rainwater system for supply of non-potable demand in a commercial building. The results demonstrated that the system has provided moderate reliability with minimal energy requirements, with performance impeded by system faults. It is suggested that ongoing monitoring of decentralised water systems as part of the building management system in commercial buildings would enable the early identification and fixing of faults. The paper also investigated other potential non-potable water sources in commercial buildings. It was found that in hot, humid environments that condensate from cooling systems could contribute a significant proportion of non-potable demand. In climates where there is considerable seasonal fluctuations condensate capture may only be suited to meeting seasonal demands, such as irrigation. Groundwater inflows are another potential water sources in commercial buildings. The feasibility of this option needs to be considered on a site specific basis as

the quality and potential yield is dependent upon the proximal aquifer and the interaction with building footings.

Acknowledgements

This work was funded under the South East Queensland Urban Water Security Research Alliance, a joint initiative between the Queensland Water Commission and CSIRO Water for a Healthy Country research flagship. Authors would like to thank the owners and building managers of the Green Square North Tower for their support and being the part of the research.

References

- ABS. Environmental Issues: Water Use and Conservation Australian Bureau of Statistics; 2010.
- ASHRAE. Thermal Environmental Conditions for Human Occupancy ANSI/ASHRAE Standard 55-10 Atlanta 2010.
- Bureau of Meteorology. Climate statistics for Australian locations – summary statistics for Brisbane Aero. Canberra: Bureau of Meteorology; 2013.
- Burnett J. City buildings—Eco-labels and shades of green! *Landscape and Urban Planning*. 2007;83:29-38.
- Chilton JC, Maidment GG, Marriott D, Francis A, Tobias G. Case study of a rainwater recovery system in a commercial building with a large roof. *Urban Water*. 2000;1:345-54.
- Cook S, Sharma A, Chong M. Performance Analysis of a Communal Residential Rainwater System for Potable Supply: A Case Study in Brisbane, Australia. *Water Resources Management*. 2013:1-12.
- Elmualim A, Shockley D, Valle R, Ludlow G, Shah S. Barriers and commitment of facilities management profession to the sustainability agenda. *Building and Environment*. 2010;45:58-64.
- EPA. Process Water Efficiency - Green Guide for Healthcare. 2007.
- Imteaz MA, Ahsan A, Shanableh A. Reliability analysis of rainwater tanks using daily water balance model: Variations within a large city. *Resources, Conservation and Recycling*. 2013;77:37-43.
- Imteaz MA, Shanableh A, Rahman A, Ahsan A. Optimisation of rainwater tank design from large roofs: A case study in Melbourne, Australia. *Resources, Conservation and Recycling*. 2011;55:1022-9.
- Jones MP, Hunt WF. Performance of rainwater harvesting systems in the southeastern United States. *Resources, Conservation and Recycling*. 2010;54:623-9.
- Khastagir A, Jayasuriya N. Optimal sizing of rain water tanks for domestic water conservation. *Journal of Hydrology*. 2010;381:181-8.

Lawrence TM, J. Perry and P. Dempsey,. Making Every Drop Count: Retrofitting Condensate Collection on HVAC Air Handling Units. *ASHRAE Journal* 2010;52:48-54.

Licina D, Sekhar C. Energy and water conservation from air handling unit condensate in hot and humid climates. *Energy and Buildings*. 2012;45:257-63.

Najia F, Lustig T. On-site water recycling — a total water cycle management approach. *Desalination*. 2006;188:195-202.

Newell. G. The strategic significance of environmental sustainability by Australian-listed property trusts. *Journal of Property Investment & Finance*. 2008;26:522-40.

Queensland Government. Geotechnical Desktop Assessment. Inner City Rail Capacity Study; Queensland Transport; 2008.

Ruth M, Bernier C, Jollands N, Golubiewski N. Adaptation of urban water supply infrastructure to impacts from climate and socioeconomic changes: The case of Hamilton, New Zealand. *Water Resources Management*. 2007;21:1031-45.

Saari A, Tissari T, Valkama E, Seppänen O. The effect of a redesigned floor plan, occupant density and the quality of indoor climate on the cost of space, productivity and sick leave in an office building—A case study. *Building and Environment*. 2006;41:1961-72.

Seneviratne M. Chapter 11 - Commercial Buildings, Hospitals and Institutional Buildings. *A Practical Approach to Water Conservation for Commercial and Industrial Facilities*. Oxford: Elsevier; 2006. p. 267-90.

Sharma A, Cook S, Tjandraatmadja G, Gregory A. Impediments and constraints in the uptake of water sensitive urban design measures in greenfield and infill developments. *Water Science & Technology*. 2012;65:340-52.

Steinfeld J, Bruce A, Watt M. Peak load characteristics of Sydney office buildings and policy recommendations for peak load reduction. *Energy and Buildings*. 2011;43:2179-87.

Wang N, Chang Y-C, Nunn C. Lifecycle assessment for sustainable design options of a commercial building in Shanghai. *Building and Environment*. 2010;45:1415-21.

Ward S, Memon FA, Butler D. Performance of a large building rainwater harvesting system. *Water Research*. 2012;46:5127-34.

Wedding GC, Crawford-Brown D. Measuring site-level success in brownfield redevelopments: A focus on sustainability and green building. *Journal of Environmental Management*. 2007;85:483-95.

WHO. Guidelines for drinking-water quality. Fourth ed: World Health Organisation. ; 2011.

Zhang Y, Grant A, Sharma A, Chen D. Assessment of rainwater use and greywater reuse in high-rise buildings in a brownfield site. *Water Science and Technology*. 2009;60:575-81.